



**HAMPDEN FENCE SUPPLY**  
Incorporated

*Proud Craftsmen Skilled in the Manufacturing of Fence Fittings.*

Specializing  
in **QUALITY** Fittings

- Bands • Hinges • Ties •
- Aluminum Fittings •
- Cantilever Rollers •



**P.O. BOX 452 • 80 INDUSTRIAL LANE • AGAWAM, MA 01001**  
**(413) 786-4390 • 1-800-891-2235 • Fax (413) 789-3664**

[www.hampdenfence.com](http://www.hampdenfence.com)

[info@hampdenfence.com](mailto:info@hampdenfence.com)

**TERMS OF SALE**

Our terms are 1% discount if paid in 10 days, otherwise net 30 days.  
\$50 Minimum order. 10% Restocking charge.

Powdercoating Available - upcharge for colors other than black.



# **INDEX**

Backstop Angle, Ductile Iron .....	9	Gate Hinges	
Barb Arms		Bull Dog Hinges, Pressed Steel .....	15
Barb Arm Bases .....	9	Female Gate Hinges, Pressed Steel.....	11
Steel Barb Arm Blades .....	9	Male Gate Hinges, Pressed Steel .....	11
Ductile Iron Corner Barb Arms .....	9	Malleable Frame Hinges .....	10
One Piece Barb Arms .....	9	Malleable Industrial Box Hinges.....	15
Brace Bands		180° Attachment .....	15
Beveled Brace Bands .....	2	Malleable Industrial Offset Hinges .....	15
C Post and Brace Bands.....	4	Malleable Post Hinges.....	10
Corner Brace Bands, B.....	1	Gate Scrolls, Three Piece.....	12
Economy Brace Bands .....		Hog Rings, Aluminum.....	6
Heavy Brace Bands.....	5	Kennel Bands .....	16
Square Brace Bands.....	4	Locking Device Kits, 5 Piece Industrial .....	14
Two Way Brace Bands, Beveled .....	3	Locking Devices, Industrial .....	14
Three Way Brace Bands, Beveled.....	3	Locking Device Rods, Cane Bolt.....	14
Cantilever Gate Roller Guards.....	13	Loop Caps.....	8
Cantilever Gate Roller Latch Assemblies .....	14	Nuts and Bolts.....	19
Cantilever Gate Rollers, Ductile Iron .....	13	Post Caps, Acorn and Dome.....	7
Cantilever Gate Rollers, Polymer .....	13	Rail Ends	
Clamps		Combination Rail Ends.....	8
End Rail Clamps.....	17	Offset Rail Ends.....	8
Heavy End Rail Clamps.....	18	5" Rear Track Wheel.....	14
Heavy Line Rail Clamps .....	18	Tension Bands	
Kennel Clamps.....	16	Beveled Tension Bands.....	2
Line Rail Clamps .....	17	Economy Tension Bands.....	1
Saddle Clamps.....	16	Heavy Tension Bands.....	5
Steel Pipe Clamps.....	21	Square Tension Bands .....	4
Drive Anchor Units .....	22	Tension Bars .....	19
Duckbill Gate Holdbacks.....	15	Top Rail Sleeves .....	10
Fence Ties, Aluminum .....	6	Truss Rod Tighteners .....	12
Floor Flanges.....	21	Welded Wire High Security Fence Hardware .....	23
Fork Latches, Pressed Steel .....	11	Wood to Steel Adapters .....	21
Frame Clamps, Pressed Steel .....	12		
Fulcrum Latches, Heavy Duty .....	20		
Gate Clips .....	1		



**B-1 TENSION BANDS - ECONOMY**

Hot Dipped Galvanized 14 Gauge x 3/4" Steel

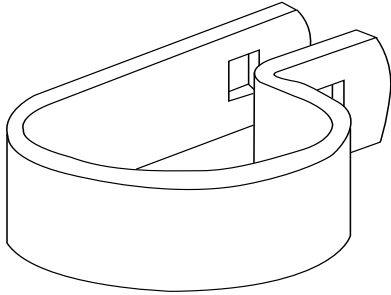

Part No.	Size	Carton	
		Weight	Quantity
TB138E	1 3/8" OD	75 LBS	500
TB158E	1 5/8" OD	78 LBS	500
TB200E	2" OD	68 LBS	400
TB250E	2 1/2" OD	54 LBS	300
TB300E	3" OD	44 LBS	200
USE CARRIAGE BOLTS NB516125 5/16" x 1 1/4"		46 LBS	1000

Available Powder Coated Black

**GATE CLIPS**

Hot Dipped Galvanized 12 Gauge x 5/8" Steel

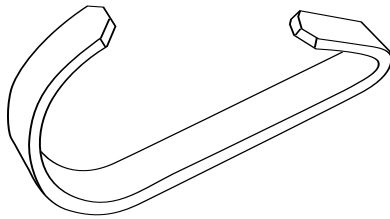

Part No.	Size	Carton	
		Weight	Quantity
GCE	1 3/8" OD	75 LBS	500

Available Powder Coated Black

**B-6 BRACE BANDS - ECONOMY**

Hot Dipped Galvanized 12 Gauge x 3/4" Steel

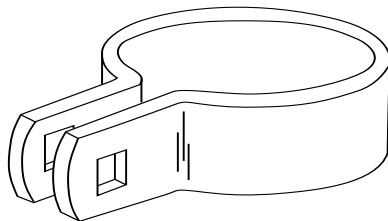

Part No.	Size	Carton	
		Weight	Quantity
BB138E	1 3/8" OD	60 LBS	500
BB158E	1 5/8" OD	64 LBS	400
BB200E	2" OD	54 LBS	300
BB250E	2 1/2" OD	66 LBS	300
BB300E	3" OD	63 LBS	250
USE CARRIAGE BOLTS NB516125 5/16" x 1 1/4"		46 LBS	1000

Available Powder Coated Black



**B-1 TENSION BANDS - BEVELED**

Hot Dipped Galvanized 12 Gauge x 13/16" Steel

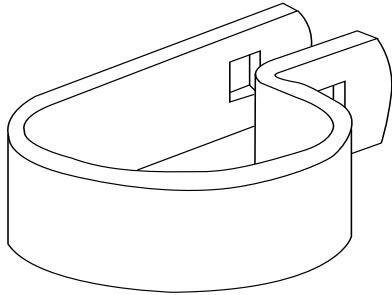

Part No.	Size	Weight	Carton Quantity
TB138B	1 3/8" OD	55 LBS	250
TB158B	1 5/8" OD	58 LBS	250
TB200B	2" OD	50 LBS	200
TB250B	2 1/2" OD	70 LBS	250
TB300B	3" OD	64 LBS	200
TB350B	3 1/2" OD	37 LBS	100
TB400B	4" OD	42 LBS	100
TB450B	4 1/2" OD	45 LBS	100
TB658B	6 5/8" OD	33 LBS	50
TB858B	8 5/8" OD	25 LBS	25
USE CARRIAGE BOLTS			
NB516125	5/16" x 1 1/4"	46 LBS	1000
Other sizes available as special order			

Available Powder Coated Black

**B-6 BRACE BANDS - BEVELED**

Hot Dipped Galvanized 12 Gauge x 59/64" Steel

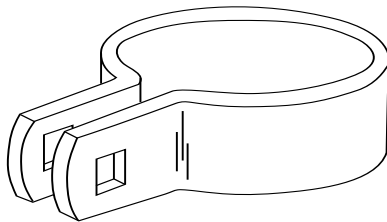

Part No.	Size	Weight	Carton Quantity
BB138B	1 3/8" OD	40 LBS	250
BB158B	1 5/8" OD	60 LBS	300
BB200B	2" OD	55 LBS	250
BB250B	2 1/2" OD	68 LBS	250
BB300B	3" OD	66 LBS	200
BB350B	3 1/2" OD	38 LBS	100
BB400B	4" OD	41 LBS	100
BB450B	4 1/2" OD	44 LBS	100
BB658B	6 5/8" OD	33 LBS	50
BB858B	8 5/8" OD	25 LBS	25
USE CARRIAGE BOLTS			
NB516125	5/16" x 1 1/4"	46 LBS	1000
Other sizes available as special order			

Available Powder Coated Black



**B-7 CORNER BRACE BANDS 90° - BEVELED**  
**Hot Dipped Galvanized 12 Gauge x 59/64" Steel**

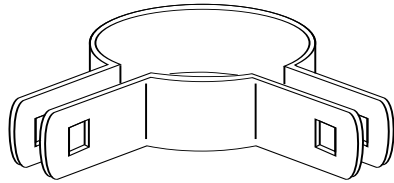

Part No.	Size	Carton	
		Weight	Quantity
CBB200	2" OD	65 LBS	250
CBB250	2 1/2" OD	62 LBS	200
CBB300	3" OD	57 LBS	150
CBB400	4" OD	44 LBS	100
USE CARRIAGE BOLTS			
NB516125	5/16" x 1 1/4"	46 LBS	1000

Available Powder Coated Black

**B-10 TWO WAY BRACE BANDS 180° - BEVELED**  
**Hot Dipped Galvanized 12 Gauge x 59/64" Steel**

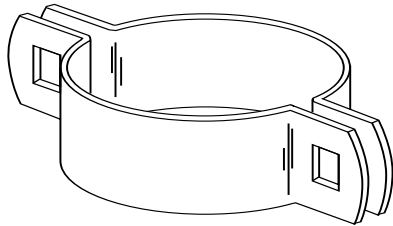

Part No.	Size	Carton	
		Weight	Quantity
2WB200	2" OD	25 LBS	100
2WB200 available as special order of 2,000 pcs.			
2WB250	2 1/2" OD	27 LBS	100
2WB300	3" OD	34 LBS	100
2WB400	4" OD	50 LBS	100
USE CARRIAGE BOLTS			
NB516125	5/16" x 1 1/4"	46 LBS	1000

Available Powder Coated Black

**THREE WAY BANDS - BEVELED**  
**Hot Dipped Galvanized 12 Gauge x 59/64" Steel**

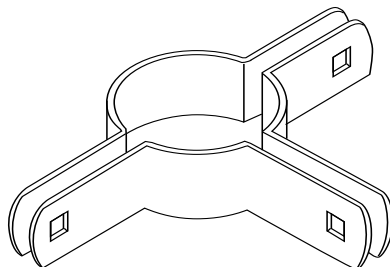

Part No.	Size	Carton	
		Weight	Quantity
3WB250	2 1/2" OD	35 LBS	100
3WB300	3" OD	41 LBS	100

Available Powder Coated Black



**SQUARE TENSION BANDS**

Hot Dipped Galvanized 12 Gauge <sup>13</sup>/<sub>16</sub>" Steel

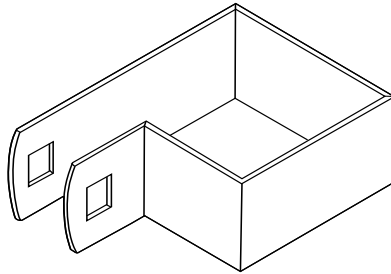

Part No.	Size	Weight	Carton Quantity
TBSQ20	2" OD	69 LBS	250
TBSQ25	2 1/2" OD	66 LBS	200
TBSQ30	3" OD	53 LBS	150
TBSQ35	3 1/2" OD	40 LBS	100
TBSQ40	4" OD	24 LBS	50
TBSQ60	6" OD	35 LBS	50

Other sizes available as special order

Available Powder Coated Black

**SQUARE BRACE BANDS**

Hot Dipped Galvanized 12 Gauge x <sup>59</sup>/<sub>64</sub>" Steel

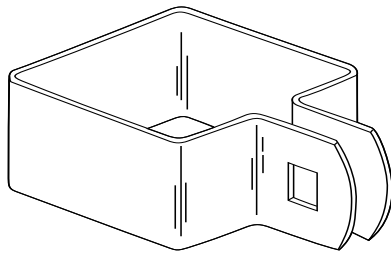

Part No.	Size	Weight	Carton Quantity
BBSQ20	2" OD	72 LBS	250
BBSQ25	2 1/2" OD	54 LBS	200
BBSQ30	3" OD	58 LBS	150
BBSQ35	3 1/2" OD	40 LBS	100
BBSQ40	4" OD	24 LBS	50
BBSQ60	6" OD	34 LBS	50

Other sizes available as special order

Available Powder Coated Black

**C POST AND H BEAM BRACE BANDS**

Hot Dipped Galvanized 12 Gauge x <sup>59</sup>/<sub>64</sub>" Steel

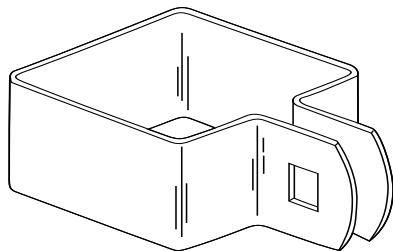

Part No.	Size	Weight	Carton Quantity
BBLAC	LARGE C POST	63 LBS	250

Available Powder Coated Black



**HEAVY TENSION BANDS**

Hot Dipped Galvanized 10 guage x 1" Steel

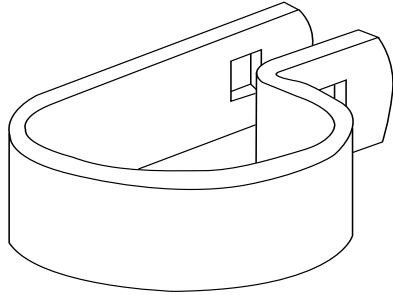

Part No.	Size	Carton	
		Weight	Quantity
TBHE15	1 <sup>5</sup> / <sub>8</sub> " OD	67 LBS	200
TBHE20	2" OD	36 LBS	100
TBHE25	2 <sup>1</sup> / <sub>2</sub> " OD	41 LBS	100
TBHE30	3" OD	49 LBS	100
TBHE35	3 <sup>1</sup> / <sub>2</sub> " OD	55 LBS	100
TBHE40	4" OD	32 LBS	50
TBHE45	4 <sup>1</sup> / <sub>2</sub> " OD	38 LBS	50
TBHE65	6 <sup>5</sup> / <sub>8</sub> " OD	50 LBS	50
USE CARRIAGE BOLTS			
NB38150	3 <sup>8</sup> / <sub>8</sub> " x 1 <sup>1</sup> / <sub>2</sub> "	88 LBS	1000
Other sizes available as special order			

Available Powder Coated Black

**HEAVY BRACE BANDS**

Hot Dipped Galvanized 10 guage x 1" Steel

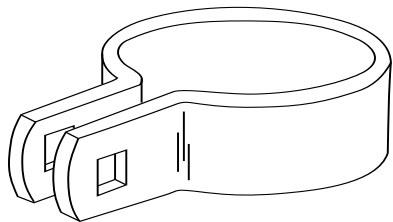

Part No.	Size	Carton	
		Weight	Quantity
BBHE20	2" OD	57 LBS	200
BBHE25	2 <sup>1</sup> / <sub>2</sub> " OD	36 LBS	100
BBHE30	3" OD	41 LBS	100
BBHE35	3 <sup>1</sup> / <sub>2</sub> " OD	47 LBS	100
BBHE40	4" OD	52 LBS	100
BBHE45	4 <sup>1</sup> / <sub>2</sub> " OD	33 LBS	50
BBHE65	6 <sup>5</sup> / <sub>8</sub> " OD	49 LBS	50
USE CARRIAGE BOLTS			
NB38150	3 <sup>8</sup> / <sub>8</sub> " x 1 <sup>1</sup> / <sub>2</sub> "	88 LBS	1000
Other sizes available as special order			

Available Powder Coated Black



**ALUMINUM FENCE TIES**

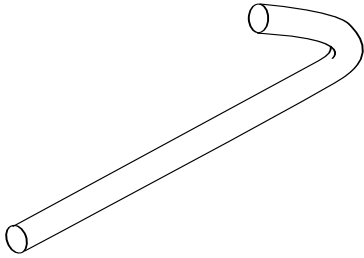

Part No.	Size	Length	Carton	
			Weight	Quantity
#13	9 GA	6 <sup>1</sup> / <sub>2</sub> "	47 LBS	3700
#16	9 GA	8 <sup>1</sup> / <sub>4</sub> "	48 LBS	3100
#23	6 GA	6 <sup>1</sup> / <sub>2</sub> "	39 LBS	1800
#26	6 GA	8 <sup>1</sup> / <sub>4</sub> "	48 LBS	1800

ALUMINUM WIRE COILS		
Size	Weight	Quantity
6 GA	35 LBS	29 FT/LB
9 GA	35 LBS	51.8 FT/LB

ALUMINUM BLACK WIRE		
Size	Weight	Quantity
6 GA	35 LBS	40 FT/LB
9 GA	35 LBS	64 FT/LB

Available Vinyl Coated Black

**ALUMINUM HOG RINGS**  
9 Gauge

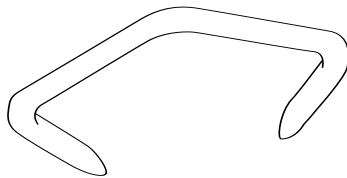

Part No.	Size	Approx Pieces/LB	Carton Weight
HOG9	9 GA	208	50 LBS

Available Vinyl Coated Black





**ALUMINUM DOME CAPS**

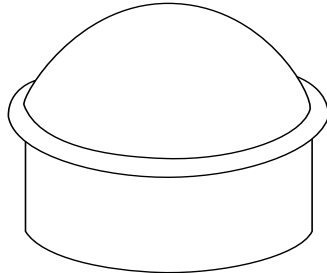

Part No.	Size	Bag	
		Weight	Quantity
ADC138	1 <sup>3</sup> / <sub>8</sub> " OD	50 LBS	500
ADC158	1 <sup>5</sup> / <sub>8</sub> " OD	75 LBS	500
ADC200	2" OD	53 LBS	250
ADC250	2 <sup>1</sup> / <sub>2</sub> " OD	70 LBS	250
ADC300	3" OD	45 LBS	100
ADC400	4" OD	36 LBS	50
ADC658	6 <sup>5</sup> / <sub>8</sub> " OD	20 LBS	10

**ALUMINUM ACORN POST CAP**

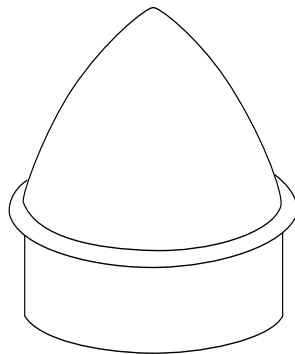

Part No.	Size	Bag	
		Weight	Quantity
APC138	1 <sup>3</sup> / <sub>8</sub> " OD	45 LBS	350
APC158	1 <sup>5</sup> / <sub>8</sub> " OD	55 LBS	300
APC200	2" OD	60 LBS	250
APC250	2 <sup>1</sup> / <sub>2</sub> " OD	62 LBS	200
APC300	3" OD	46 LBS	100
APC400	4" OD	50 LBS	50
APC658	6 <sup>5</sup> / <sub>8</sub> " OD	19 LBS	10

Available Vinyl Coated Black

**PRESSED STEEL POST CAPS**

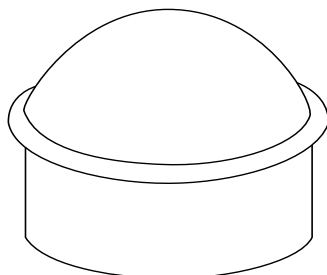

Part No.	Size	Bag	
		Weight	Quantity
PSPC158	1 <sup>5</sup> / <sub>8</sub> " OD	27 LBS	200
PSPC200	2" OD	41 LBS	200
PSPC238	2 <sup>3</sup> / <sub>8</sub> " OD	41 LBS	150
PSPC300	2 <sup>7</sup> / <sub>8</sub> " OD	53 LBS	150
PSPC350	3 <sup>1</sup> / <sub>2</sub> " OD	46 LBS	100
PSPC400	4" OD	58 LBS	100
PSPC450	4 <sup>1</sup> / <sub>2</sub> " OD	74 LBS	100
PSPC658	6 <sup>5</sup> / <sub>8</sub> " OD	15 LBS	10
PSPC858	8 <sup>5</sup> / <sub>8</sub> " OD	18 LBS	8

Available Vinyl Coated Black



**ALUMINUM LOOP CAPS**

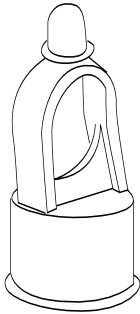

Part No.	Size	Weight	Bag Quantity
ALC158	1 <sup>5</sup> / <sub>8</sub> " x 1 <sup>3</sup> / <sub>8</sub> "	75 LBS	250
ALC213	2" x 1 <sup>3</sup> / <sub>8</sub> "	60 LBS	200
ALC215	2" x 1 <sup>5</sup> / <sub>8</sub> "	53 LBS	150
ALC255	2 <sup>1</sup> / <sub>2</sub> " x 1 <sup>5</sup> / <sub>8</sub> "	75 LBS	100

Available Vinyl Coated Black

**PRESSED STEEL LOOP CAPS**

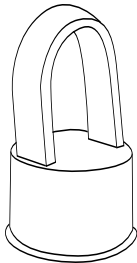

Part No.	Size	Weight	Carton Quantity
PSLC1513	1 <sup>5</sup> / <sub>8</sub> " x 1 <sup>3</sup> / <sub>8</sub> "	14 LBS	50
PSLC1515	1 <sup>5</sup> / <sub>8</sub> " x 1 <sup>5</sup> / <sub>8</sub> "	15 LBS	50
PSLC2138	2" x 1 <sup>3</sup> / <sub>8</sub> "	17 LBS	50
PSLC2158	2" x 1 <sup>5</sup> / <sub>8</sub> "	19 LBS	50
PSLC2358	2 <sup>1</sup> / <sub>2</sub> " x 1 <sup>5</sup> / <sub>8</sub> "	23 LBS	50
PSLC3158	3 x 1 <sup>5</sup> / <sub>8</sub> "	30 LBS	50
PSLC3558	3 <sup>1</sup> / <sub>2</sub> " x 1 <sup>5</sup> / <sub>8</sub> "	42 LBS	50
PSLC4158	4 x 1 <sup>5</sup> / <sub>8</sub> "	46 LBS	50
PSLC4558	4 <sup>1</sup> / <sub>2</sub> " x 1 <sup>5</sup> / <sub>8</sub> "	52 LBS	50

Available Powder Coated Black

**ALUMINUM OFFSET RAIL ENDS**

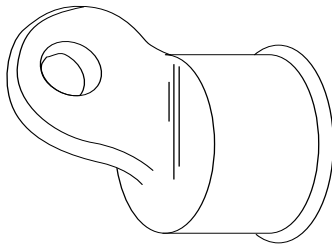

Part No.	Size	Weight	Bag Quantity
ARE138	1 <sup>3</sup> / <sub>8</sub> " OD	38 LBS	250
ARE158	1 <sup>5</sup> / <sub>8</sub> " OD	51 LBS	250

Available Vinyl Coated Black

**PRESSED STEEL OFFSET RAIL ENDS**

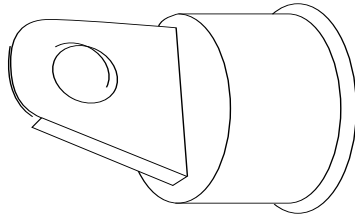

Part No.	Size	Weight	Bag Quantity
PSRE138	1 <sup>3</sup> / <sub>8</sub> " OD	20 LBS	100
PSRE158	1 <sup>5</sup> / <sub>8</sub> " OD	25 LBS	100
PSRE200	2" OD	31 LBS	100

Available Powder Coated Black

**COMBINATION RAIL ENDS**

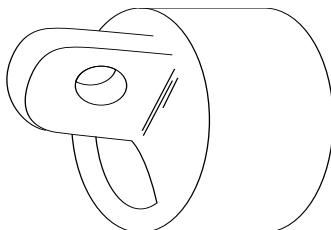

Part No.	Size	Weight	Bag Quantity
Malleable CRE158	1 <sup>5</sup> / <sub>8</sub> " OD	42 LBS	100
Pressed Steel PSCRE158	1 <sup>5</sup> / <sub>8</sub> " OD	22 LBS	100
PSCRE200	2" OD	26 LBS	100

Available Powder Coated Black

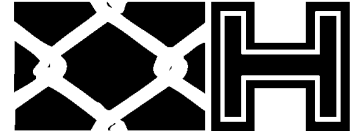

**DUCTILE IRON BACKSTOP ANGLE**

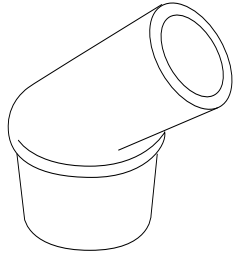

Part No.	Size	Weight	Bag Quantity
BAS	Fits 3" or 4" Post	51 LBS	12

**STEEL BARB ARM BLADES**

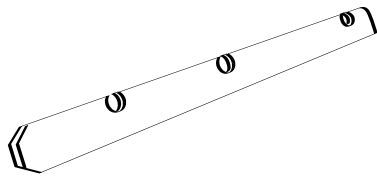

Part No.	Size	Weight	Bag Quantity
BARB ARM	3 STRAND	45 LBS	50

**PRESSED STEEL CORNER BARB ARMS**

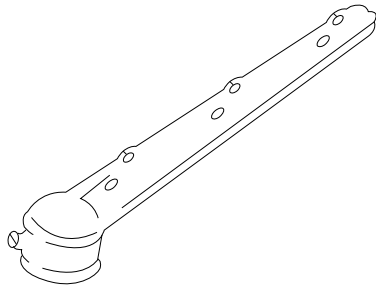

Part No.	Size	Weight	Bag Quantity
CBA250	2 1/2" OD	30 LBS	12
CBA300	3" OD	34 LBS	12
CBA400	4" OD	18 LBS	5

PRICES INCLUDE SET SCREW

**ONE PIECE BARB ARMS**

Available Powder Coated Black

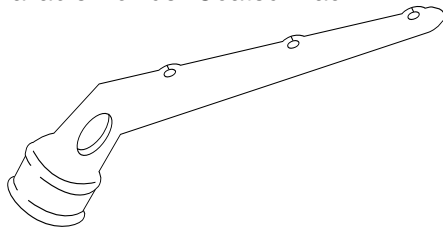

Part No.	Size	Weight	Bag Quantity
1PBA15	1 5/8" x 1 5/8"	30 LBS	25
1PBA20	2" x 1 5/8"	34 LBS	25
1PBA25	2 1/2" x 1 5/8"	40 LBS	25
1PBA30	3" x 1 5/8"	47 LBS	20

**BARB ARM BASES - MALLEABLE**

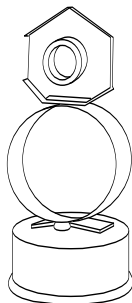

Part No.	Size	Weight	Bag Quantity
BAB2158	2" x 1 5/8"	64 LBS	50
BAB2558	2 1/2" x 1 5/8"	37 LBS	25



**TOP RAIL SLEEVES**

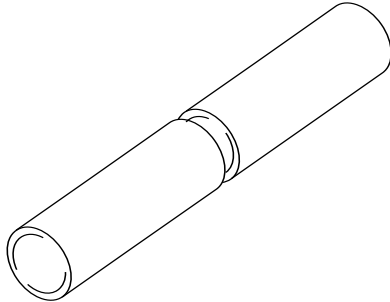

Part No.	Size	Weight	Bag Quantity
TRS138	1 3/8" OD	32 LBS	100
TRS158	1 5/8" OD	39 LBS	100

Available Powder Coated Black

**FRAME HINGE - MALLEABLE**  
Residential Female Hinge

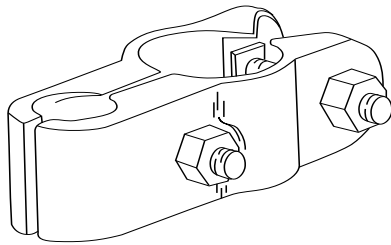

Part No.	Size	Weight	Bag Quantity
RFH138	1 3/8" OD	38 LBS	50
RFH158	1 5/8" OD	50 LBS	50
BOLTS INCLUDED			

**POST HINGE - MALLEABLE**  
Residential Post Hinge

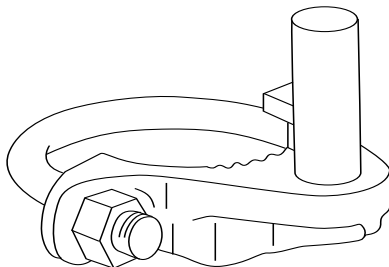

Part No.	Size	Weight	Bag Quantity
RPH200	2" OD	32 LBS	50
RPH250	2 1/2" OD	46 LBS	50
RPH300	3" OD	47 LBS	50
BOLTS INCLUDED			



**FEMALE GATE HINGES - PRESSED STEEL**  
Hot Dipped Galvanized

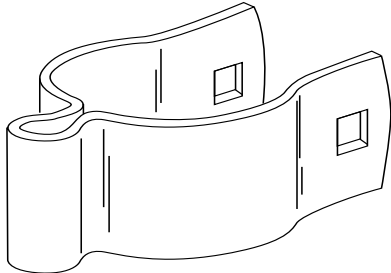

Part No.	Size	Carton	
		Weight	Quantity
FH138	1 <sup>3</sup> / <sub>8</sub> " OD	30 LBS	100
FH158	1 <sup>5</sup> / <sub>8</sub> " OD	38 LBS	100
FH200	2" OD	41 LBS	100
DOES NOT INCLUDE BOLTS			

Available Powder Coated Black

**MALE GATE HINGES - PRESSED STEEL**  
Hot Dipped Galvanized

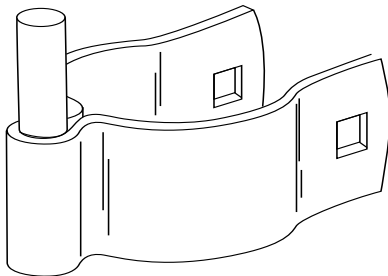

Part No.	Size	Carton	
		Weight	Quantity
MH138	1 <sup>3</sup> / <sub>8</sub> " OD	46 LBS	100
MH158	1 <sup>5</sup> / <sub>8</sub> " OD	55 LBS	100
MH200	2" OD	58 LBS	100
MH250	2 <sup>1</sup> / <sub>2</sub> " OD	63 LBS	100
MH300	3" OD	68 LBS	50
DOES NOT INCLUDE BOLTS			

Available Powder Coated Black

**FORK LATCHES - PRESSED STEEL**  
Hot Dipped Galvanized

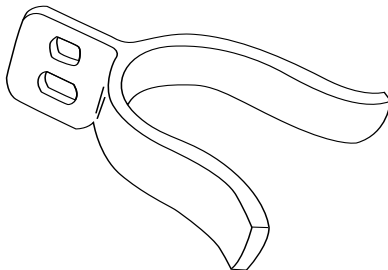

Part No.	Size	Carton	
		Weight	Quantity
FL138	1 <sup>3</sup> / <sub>8</sub> " OD	35 LBS	100
FL200	2" OD	39 LBS	100
FL250	2 <sup>1</sup> / <sub>2</sub> " OD	42 LBS	100
FL300	3" OD	49 LBS	100
FL400	4" OD	39 LBS	50
DOES NOT INCLUDE BOLTS			

Available Powder Coated Black



**FRAME CLAMPS - PRESSED STEEL**

Hot Dipped Galvanized

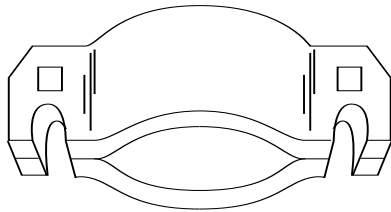

Part No.	Size	Weight	Carton Quantity
FC138	1 3/8" OD	38 LBS	100
FC158	1 5/8" OD	40 LBS	100
FC200	2" OD	50 LBS	100

DOES NOT INCLUDE BOLTS

Available Powder Coated Black

**GATE SCROLLS - THREE PIECE**

Hot Dipped Galvanized 12 Gauge x 3/4" Steel

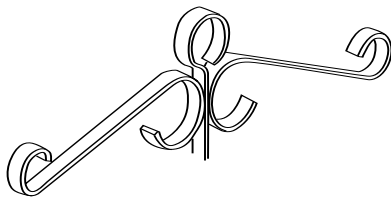

Part No.	Size	Weight	Bag Quantity
3PGS18	18" OD	49 LBS	50
3PGS24	24" OD	13 LBS	10

DOES NOT INCLUDE BOLTS

Available Powder Coated Black

**GATE TRUSS ROD TIGHTENERS**

Standard Industrial - 1/4" x 4 3/4"

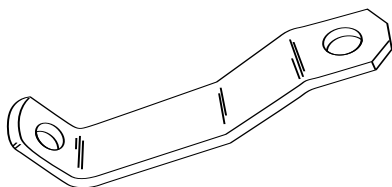

Part No.	Weight	Bag Quantity
TRT125	55 LBS	150

DOES NOT INCLUDE BOLTS

Available Powder Coated Black



**CANTILEVER GATE ROLLERS - MALLEABLE**

Grease Needle Bearing

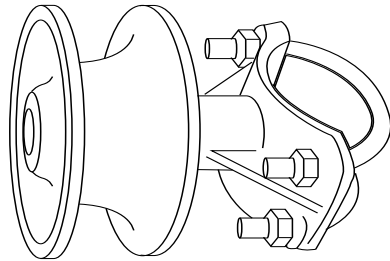

Part No.	Size	Carton	
		Weight	Quantity
CRH300	2 <sup>7</sup> / <sub>8</sub> " x 2 <sup>7</sup> / <sub>8</sub> "	24 LBS	2
CRH400	4" x 2 <sup>3</sup> / <sub>8</sub> "	28 LBS	2
CRH658	6 <sup>5</sup> / <sub>8</sub> " x 2 <sup>3</sup> / <sub>8</sub> "	33 LBS	4

**MINI CANTILEVER GATE ROLLERS - MALLEABLE**

Sealed Ball Bearing

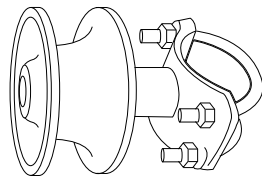

Part No.	Size	Carton	
		Weight	Quantity
CR250	2 <sup>3</sup> / <sub>8</sub> " x 1 <sup>5</sup> / <sub>8</sub> "	12 LBS	8

**CANTILEVER GATE ROLLERS - NYLON**

Sealed Ball Bearing

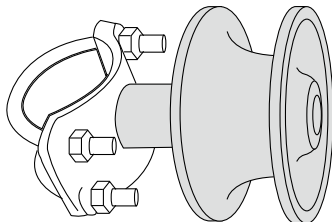

Part No.	Size	Carton	
		Weight	Quantity
NCR278	2 <sup>7</sup> / <sub>8</sub> " x 2 <sup>3</sup> / <sub>8</sub> "	46 LBS	4
NCR350	3 <sup>1</sup> / <sub>2</sub> " x 2 <sup>3</sup> / <sub>8</sub> "	48 LBS	4
NCR400	4" x 2 <sup>3</sup> / <sub>8</sub> "	50 LBS	4
NCR450	4 <sup>1</sup> / <sub>2</sub> " x 2 <sup>3</sup> / <sub>8</sub> "	52 LBS	4
NCR658	6 <sup>5</sup> / <sub>8</sub> " x 2 <sup>3</sup> / <sub>8</sub> "	54 LBS	4

**POLYMER CANTILEVER GATE ROLLERS - WITH GUARDS**

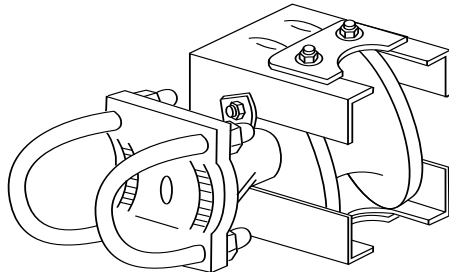

Part No.	Size	Carton	
		Weight	Quantity
PCR300	3" x 2 <sup>1</sup> / <sub>2</sub> "	33 LBS	2
PCR400	4" x 2 <sup>1</sup> / <sub>2</sub> "	37 LBS	2
PCR658	6 <sup>5</sup> / <sub>8</sub> " x 2 <sup>1</sup> / <sub>2</sub> "	45 LBS	2

**CANTILEVER ROLLER GUARDS**

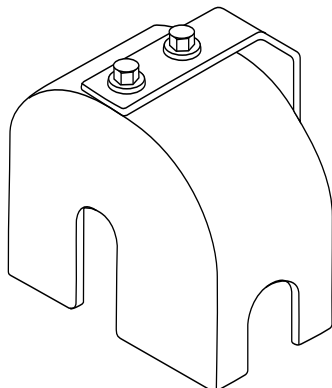

Made of 16 gauge hot dipped galvanized steel. It is designed to fit either round or square gate posts. Cover fits all standard 3" , 4" and 6<sup>5</sup>/<sub>8</sub>" cantilever rollers. It covers the rollers completely while leaving access to grease fitting. Improves the look of the finished product.

Used only on top - Bottom is optional

Part No.	Size	Bag	
		Weight	Quantity
CRC	Fits 3" , 4" , 6 <sup>5</sup> / <sub>8</sub> "	7 LBS	4



**LATCH ASSEMBLY FOR CANTILEVER GATES - MALLEABLE**

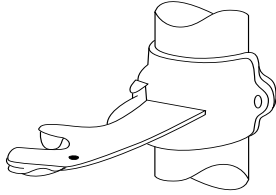

Part No.	Size	Carton Weight	Carton Quantity
CL300	3"	83 LBS	12
CL400	4"	88 LBS	12

Includes 2" Receiver

**REAR TRACK WHEEL**

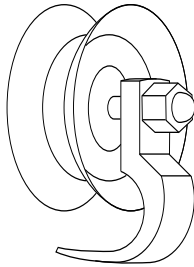

Part No.	Size	Carton Weight	Carton Quantity
5" Wheel	5"	66 LBS	10

**INDUSTRIAL LOCKING DEVICE KIT - MALLEABLE**

5 piece set, 1<sup>5</sup>/<sub>8</sub>" or 2"

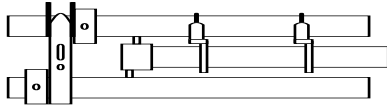

Part No.	Weight	Qty.
5PCILD 5 PIECE SET	55 LBS	8

Available Powder Coated Black

**CANE BOLT ROD / DROP ROD**



Part No.	Size	Bag Weight	Bag Quantity
DROP ROD	1/2" x 30" x 4"	44 LBS	25
DROP ROD	1/2" x 36" x 4"	51 LBS	25

Available Powder Coated Black

**INDUSTRIAL DROP FORK AND GUIDE**

Hot Dipped Galvanized Steel

Fits 2" Gate Frames.

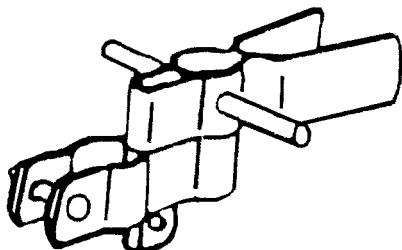

Part No.	Size	Carton Weight	Carton Quantity
ILDFOR158	1 <sup>5</sup> / <sub>8</sub> " w/Pin	56 LBS	50
ILDFOR200	2" w/Pin	55 LBS	50
ILDGUI		35 LBS	50



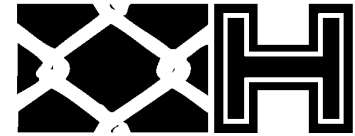

**MALLEABLE INDUSTRIAL BOX HINGE COMPLETE**  
**Ball And Socket Type - Fits Both 1<sup>5</sup>/<sub>8</sub>" And 2" Gate Frame**

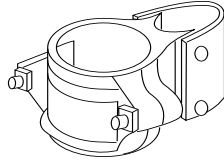

Part No.	Size	Weight	Bag Quantity
BOX250	2 <sup>1</sup> / <sub>2</sub> "	63 LBS	12
BOX300	3"	68 LBS	12
BOX400	4"	91 LBS	12
BOX658	6 <sup>5</sup> / <sub>8</sub> "	63 LBS	4
BOX858	8 <sup>5</sup> / <sub>8</sub> "	93 LBS	4

Available Powder Coated Black

**MALLEABLE INDUSTRIAL BOX HINGE ATTACHMENT - 180°**

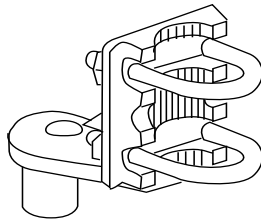

Part No.	Size	Weight	Bag Quantity
180ADA	1 <sup>5</sup> / <sub>8</sub> " x 2"	66 LBS	12

Available Powder Coated Black

**BULL DOG HINGE - PRESSED STEEL**

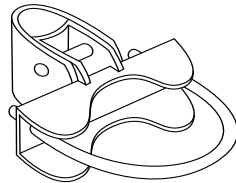

Part No.	Size	Weight	Bag Quantity
BDH250	2 <sup>1</sup> / <sub>2</sub> "	42 LBS	12
BDH300	3"	44 LBS	12
BDH400	4"	46 LBS	12
BDH658	6 <sup>5</sup> / <sub>8</sub> "	22 LBS	4

Available Powder Coated Black

**MALLEABLE INDUSTRIAL OFFSET HINGES**  
**Fits Both 1<sup>5</sup>/<sub>8</sub>" & 2" Gate Frame**

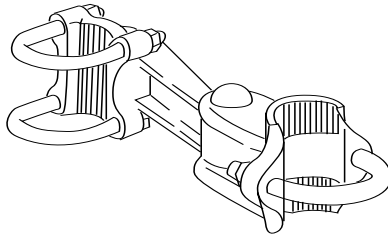

Part No.	Size	Weight	Bag Quantity
OFF238	2 <sup>1</sup> / <sub>2</sub> "	68 LBS	12
OFF300	3"	73 LBS	12
OFF400	4"	83 LBS	12
OFF658	6 <sup>5</sup> / <sub>8</sub> "	53 LBS	4

Available Powder Coated Black

**DUCKBILL GATE HOLDBACKS**  
**Ductile Iron**

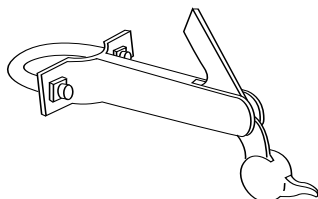

Part No.	Weight	Bag Quantity
DUCKHB	53 LBS	25
PRICE INCLUDES U-BOLT & 5/16" x 1 <sup>1</sup> / <sub>2</sub> " BOLTS		



**KENNEL CLAMPS**

Hot Dipped Galvanized 13 Gauge x 1 1/2" Steel

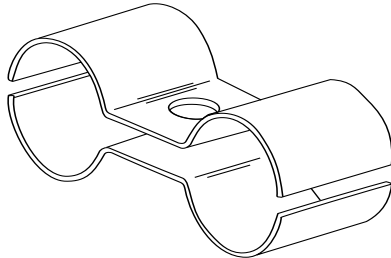

Part No.	Size	Weight	Carton Quantity
KENCLA	1 3/8" x 1 3/8"	54 LBS	125
USE CARRIAGE BOLTS			
NB516125	5/16" x 1 1/4"	46 LBS	1000
Also Available in 12 Gauge as Special Order: KENCLA12G 1 3/8" x 1 3/8"			

Available Powder Coated Black

**SADDLE CLAMPS**

Hot Dipped Galvanized 8 Gauge x 1 1/4" Steel

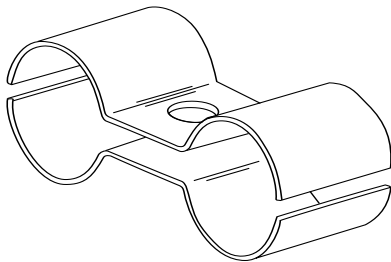

Part No.	Size	Weight	Carton Quantity
SC1515	1 5/8" x 1 5/8"	68 LBS	100
USE CARRIAGE BOLTS			
NB38150	3/8" x 1 1/2"	88 LBS	1000

Available Powder Coated Black

**KENNEL BANDS**

Hot Dipped Galvanized 14 Gauge x 3/4" Steel

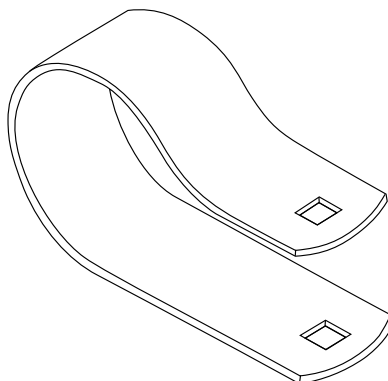

Part No.	Size	Weight	Carton Quantity
KENBAN	1 3/8" OD	71 LBS	500
USE CARRIAGE BOLTS			
NB516125	5/16" x 1 1/4"	46 LBS	1000

Available Powder Coated Black



**END RAIL CLAMPS**  
Hot Dipped Galvanized 13 Gauge Steel

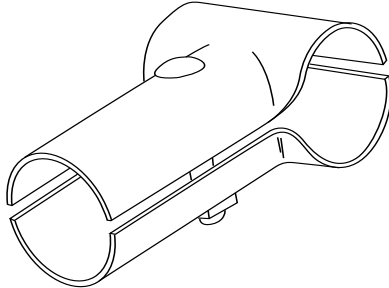

Part No.	Size	Weight	Carton Quantity
EC1313	1 <sup>3</sup> / <sub>8</sub> " x 1 <sup>3</sup> / <sub>8</sub> "	40 LBS	100
EC1513	1 <sup>5</sup> / <sub>8</sub> " x 1 <sup>3</sup> / <sub>8</sub> "	35 LBS	100
EC2138	2" x 1 <sup>3</sup> / <sub>8</sub> "	50 LBS	100
USE CARRIAGE BOLTS			
NB516250	5/16" x 2 <sup>1</sup> / <sub>2</sub> "	70 LBS	1000
EC1515	1 <sup>5</sup> / <sub>8</sub> " x 1 <sup>5</sup> / <sub>8</sub> "	55 LBS	100
EC2158	2" x 1 <sup>5</sup> / <sub>8</sub> "	55 LBS	100
EC2558	2 <sup>1</sup> / <sub>2</sub> " x 1 <sup>5</sup> / <sub>8</sub> "	34 LBS	50
EC3158	3" x 1 <sup>5</sup> / <sub>8</sub> "	37 LBS	50
EC3558	3 <sup>1</sup> / <sub>2</sub> " x 1 <sup>5</sup> / <sub>8</sub> "	40 LBS	50
EC4158	4" x 1 <sup>5</sup> / <sub>8</sub> "	42 LBS	50
USE CARRIAGE BOLTS			
NB38250	3/8" x 2 <sup>1</sup> / <sub>2</sub> "	98 LBS	1000
Also Available in 12 Gauge as Special Order:			
EC1313	1 <sup>3</sup> / <sub>8</sub> " x 1 <sup>3</sup> / <sub>8</sub> "		100

Available Powder Coated Black

**LINE RAIL CLAMPS**  
Hot Dipped Galvanized 13 Gauge Steel

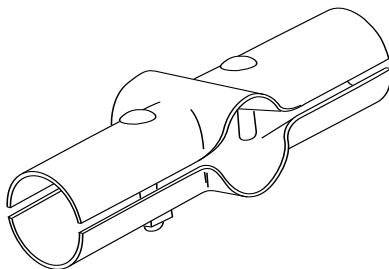

Part No.	Size	Weight	Carton Quantity
LC1313	1 <sup>3</sup> / <sub>8</sub> " x 1 <sup>3</sup> / <sub>8</sub> "	60 LBS	100
LC1513	1 <sup>5</sup> / <sub>8</sub> " x 1 <sup>3</sup> / <sub>8</sub> "	60 LBS	100
LC2138	2" x 1 <sup>3</sup> / <sub>8</sub> "	37 LBS	50
USE CARRIAGE BOLTS			
NB516250	5/16" x 2 <sup>1</sup> / <sub>2</sub> "	70 LBS	1000
LC1515	1 <sup>5</sup> / <sub>8</sub> " x 1 <sup>5</sup> / <sub>8</sub> "	38 LBS	50
LC2158	2" x 1 <sup>5</sup> / <sub>8</sub> "	40 LBS	50
LC2558	2 <sup>1</sup> / <sub>2</sub> " x 1 <sup>5</sup> / <sub>8</sub> "	50 LBS	50
LC3158	3" x 1 <sup>5</sup> / <sub>8</sub> "	60 LBS	50
LC3558	3 <sup>1</sup> / <sub>2</sub> " x 1 <sup>5</sup> / <sub>8</sub> "	65 LBS	50
LC4158	4" x 1 <sup>5</sup> / <sub>8</sub> "	70 LBS	50
LCLAC	LRG C x 1 <sup>5</sup> / <sub>8</sub> "	50 LBS	50
LCSRH	SRH x 1 <sup>5</sup> / <sub>8</sub> "	50 LBS	50
USE CARRIAGE BOLTS			
NB38250	3/8" x 2 <sup>1</sup> / <sub>2</sub> "	98 LBS	1000

Available Powder Coated Black



**HEAVY END RAIL CLAMPS**  
Hot Dipped Galvanized 3/16" Steel

Used by N.Y.C. Parks Dept, N.Y.C. School Construction Authority, Board of Education, N.Y. D.O.T.

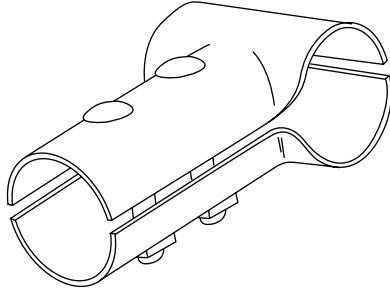

Part No.	Size	Carton	
		Weight	Quantity
ECHE1515	1 5/8" X 1 5/8"	30LBS	25
ECHE2158	2" X 1 5/8"	31LBS	25
ECHE2558	2 1/2" X 1 5/8"	38LBS	25
ECHE3158	3" X 1 5/8"	42LBS	25
ECHE3558	3 1/2" X 1 5/8"	48LBS	25
ECHE4158	4" X 1 5/8"	53LBS	25
USE CARRIAGE BOLTS			
NB38250	3/8" X 2 1/2"	98LBS	1000

Corner Clamps Available. 20pc../Ctn.

Available Powder Coated Black

**HEAVY LINE RAIL CLAMPS**  
Hot Dipped Galvanized 3/16" Steel

Used by N.Y.C. Parks Dept, N.Y.C. School Construction Authority, Board of Education, N.Y. D.O.T.

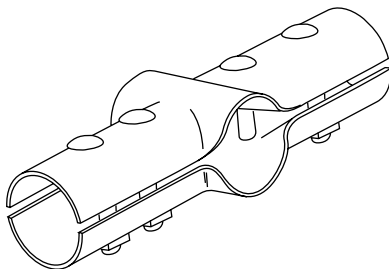

Part No.	Size	Carton	
		Weight	Quantity
LCHE1515	1 5/8" X 1 5/8"	43LBS	25
LCHE2158	2" X 1 5/8"	43LBS	25
LCHE2558	2 1/2" X 1 5/8"	51LBS	25
LCHE3158	3" X 1 5/8"	54LBS	25
LCHE3558	3 1/2" X 1 5/8"	60LBS	25
LCHE4158	4" X 1 5/8"	65LBS	25
USE CARRIAGE BOLTS			
NB38250	3/8" X 2 1/2"	98LBS	1000

Corner Clamps Available. 20pc../Ctn.

Available Powder Coated Black



**CARRIAGE BOLTS AND NUTS**  
Hot Dipped Galvanized

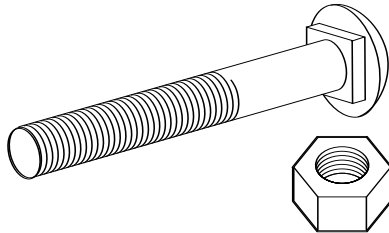

Select Sizes Available HDG  
And Coated Black

Part No.	Size	Weight	Carton Quantity
NB516125	5/16" x 1 1/4"	92 LBS	2000
NB516150	5/16" x 1 1/2"	48 LBS	1000
NB516175	5/16" x 1 3/4"	50 LBS	1000
NB516200	5/16" x 2"	60 LBS	1000
NB516250	5/16" x 2 1/2"	70 LBS	1000
NB516300	5/16" x 3"	72 LBS	1000
NB516350	5/16" x 3 1/2"	74 LBS	1000
NB516400	5/16" x 4"	76 LBS	1000
NB516450	5/16" x 4 1/2"	78 LBS	1000
NB38150	3/8" x 1 1/2"	88 LBS	1000
NB38200	3/8" x 2"	90 LBS	1000
NB38250	3/8" x 2 1/2"	98 LBS	1000
NB38300	3/8" x 3"	105 LBS	1000
NB38350	3/8" x 3 1/2"	65 LBS	500
NB38400	3/8" x 4"	70 LBS	500
NB38450	3/8" x 4 1/2"	80 LBS	500

MINIMUM ORDER OF 100 PIECES

**TENSION BARS**  
Hot Dipped Galvanized

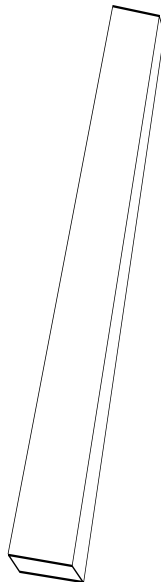

**3/16" x 5/8" Steel Bars**

Part No.	Size	Weight	Carton Quantity
BAR540	47"	39 LBS	50
BAR550	59"	49 LBS	50
BAR560	71"	60 LBS	50

\*Available Powder Coated Black Steel

**3/16" x 3/8" Mini Bars - Black Only**

Part No.	Size	Weight	Carton Quantity
BAR4BLACK	4'	19 LBS	25
BAR5BLACK	5'	24 LBS	25
BAR6BLACK	6'	29 LBS	25

**3/16" x 3/4" Steel Bars**

Part No.	Size	Weight	Carton Quantity
BAR360	71"	68 LBS	25
BAR370	83"	80 LBS	25
BAR380	95"	91 LBS	25
BAR310	119"	114 LBS	25
BAR312	144"	137 LBS	25

\*Available Powder Coated Black Steel



**HEAVY DUTY FULCRUM LATCH**  
Hot Dipped Galvanized

**DOUBLE LATCH**

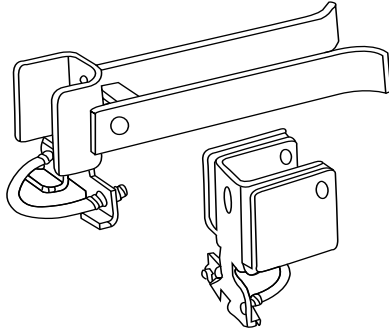

FL1717 DOUBLE

**SINGLE LATCH**

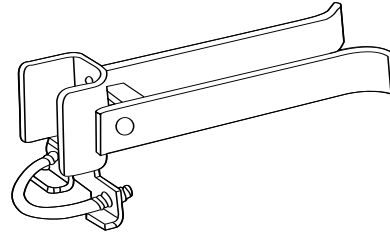

FL1730 SINGLE  
FL1740 SINGLE

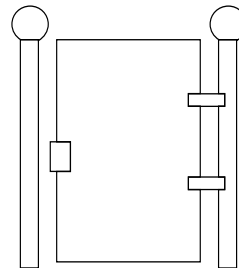
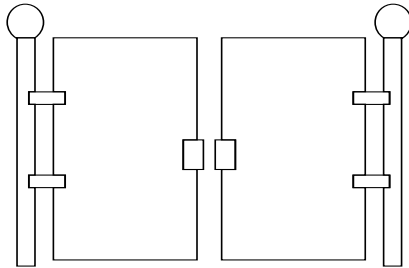

Part No.	Size	Description	Weight	Carton Quantity
FL1717 DOUBLE	17/8" x 17/8"	FITS 15/8" - 17/8" FRAME ADJ. 2"-6" GAP	50 LBS	6
FL1730 SINGLE	17/8" x 3"	FITS 15/8" - 17/8" FRAME FITS 3" POST ALLOWS 2"-4" GAP	42 LBS	8
FL1740 SINGLE	17/8" x 4"	FITS 15/8" - 17/8" FRAME FITS 4" POST ALLOWS 2"-4" GAP	45 LBS	8/CASE

Available Powder Coated Black

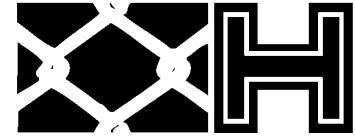

**FLOOR FLANGES**

1/4" Thick

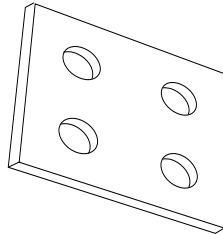

Part No.	Size	Carton/Bag	
		Weight	Quantity
FF3X6	3" x 6"	60 LBS	50
FF4X4	4" x 4"	50 LBS	50
FF5X5	5" x 5"	41 LBS	25
FF6X6	6" x 6"	45 LBS	20
FF8X8	8" x 8"	83 LBS	20

**STEEL PIPE CLAMPS - WOOD TO STEEL ADAPTERS**

Hot Dipped Galvanized 12 Gauge x 59/64" Steel

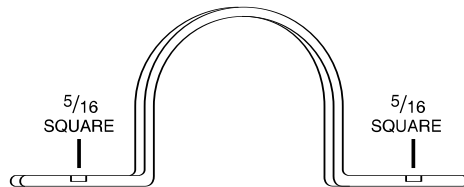

Part No.	Size	Carton	
		Weight	Quantity
WSA158	1 5/8" OD	21 LBS	100
WSA178	1 7/8" OD	22 LBS	100
WSA250	2 1/2" OD	26 LBS	100
WSA300	3" OD	27 LBS	100
WSA400	4" OD	37 LBS	100

**LINE ADAPTERS - WOOD TO STEEL**

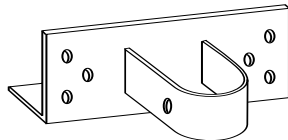

Part No.	Size	Carton/Bag	
		Weight	Quantity
WSALINE	1 5/8" x 6"	43 LBS	50
WSALINE	2" x 6"	44 LBS	50
WSALINE	2 1/2" x 6"	47 LBS	50
WSALINE	2" x 8"	52 LBS	50
WSALINE	2 1/2" x 8"	56 LBS	50
WSALINE	3" x 8"	58 LBS	50

**END ADAPTERS - WOOD TO STEEL**

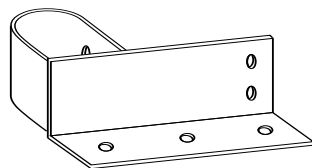

Part No.	Size	Carton/Bag	
		Weight	Quantity
WSAEND	1 5/8" x 6"	33 LBS	50
WSAEND	2" x 6"	33 LBS	50
WSAEND	2 1/2" x 6"	39 LBS	50
WSAEND	3" x 8"	54 LBS	50

**CORNER ADAPTERS - WOOD TO STEEL**

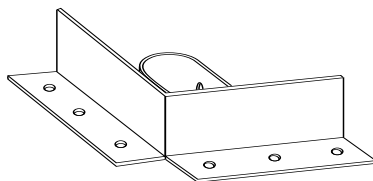

Part No.	Size	Carton/Bag	
		Weight	Quantity
WSACorner	1 5/8" x 6"	52 LBS	50
WSACorner	2" x 6"	53 LBS	50
WSACorner	2 1/2" x 6"	61 LBS	50
WSACorner	3" x 8"	64 LBS	50



**DRIVE ANCHOR UNIT**

8ga. x 1 1/4" Pressed Steel

Fits Posts Up To 3 1/2", JRH Beam, Small C Post and Square Post

Hot Dipped Galvanized Steel - Available with 5/16" or 3/8" hole

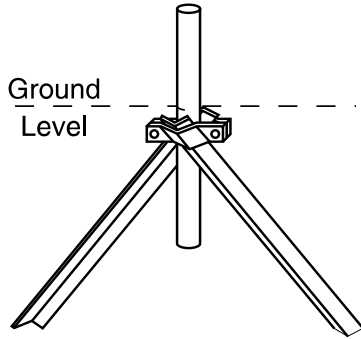

**COMPLETE UNIT INCLUDES:**

2 Anchor Blades 1" x 1" x 1/8" x 30" 2.05 LBS EA  
 1 Shoe (Carton Qty. 50 sets) 33 LBS.Ctn  
 2 Nuts and Bolts for Round Post 5/16" hole  
 For length of bolt add 1" to size of pipe.

**RDA COMPLETE UNIT Carton/Bundle**  
**Part No. Weight Quantity**

DAS516 1 SET PER UNIT 38 LBS 50 sets  
 DAB10030 2 BLADES/UNIT

USES 2 CARRIAGE BOLTS EACH 3/8" hole

**INDUSTRIAL DRIVE ANCHOR UNIT**

Fits Up To 3 1/2" OD Post, SRH Beam, Large C Post and Square Post

Hot Dipped Galvanized Steel 8 ga. x 1 1/4" Pressed Steel

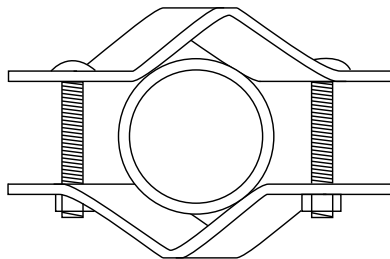

**REQUIRES** 2 - 1 1/4" x 1 1/4" x 1/8" x 30" Anchor Blades

**REQUIRES** 2 - Nuts + Bolts

**REQUIRES** 1 - Shoe

**Part Carton/Bundle**  
**No. Weight Quantity**

DAS38 2pc. 38 LBS 50 sets  
 DAB12530 1 1/4" x 1 1/4" x 1/8" x 30" 68 LBS 25 pc.  
 DAB10030 1" x 1" x 1/8" x 30" 2.05 LBS EA  
 DAB15030 1 1/2" x 1 1/2" x 1/8" x 30" 3.30 LBS EA

**RECOMMENDED BOLT LENGTH**

**Square Post**

2" Post - Use 3/8" x 4" Bolt  
 2 1/2" Post - Use 3/8" x 4 1/2" Bolt  
 3" Post - Use 3/8" x 5" Bolt  
 3 1/2" Post - Use 3/8" x 5 1/2" Bolt

**Round Post**

1 1/2" Post - Use 3/8" x 3" Bolt  
 2" Post - Use 3/8" x 3 1/2" Bolt  
 2 1/2" Post - Use 3/8" x 4" Bolt  
 3" Post - Use 3/8" x 4 1/2" Bolt  
 3 1/2" Post - Use 3/8" x 5" Bolt  
 SRH Post - Use 3/8" x 4" Bolt  
 Heavy/Large C Post - Use 3/8" x 4" Bolt

**DASLAR 2pc. - LARGE INDUSTRIAL DRIVE ANCHOR SHOE**

Fits 4" and 4 1/2" Post, 8 ga. x 1 1/4" Pressed Steel, BOX: 50sets - 46 LBS



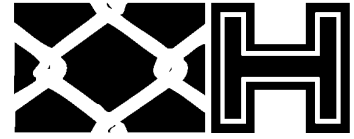

**WELDED WIRE HIGH SECURITY FENCE HARDWARE - 10 Gauge**

**High security fence panels are attached to line posts, terminal posts and gate frames with 1/8" x 1" hot dip galvanized post brackets.**

MINIMUM ORDER 2,000 SETS PER SIZE, 4-6 WEEKS DELIVERY

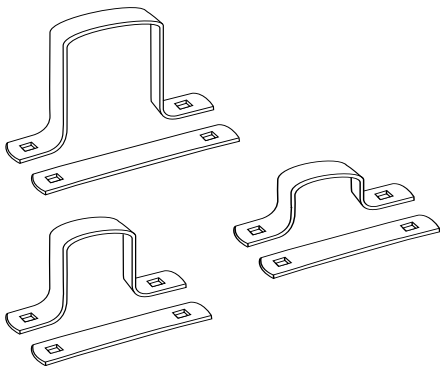

<b>C POST BRACKET</b>			
Part No.	Size	Weight	Quantity
HFSFC1625	1 <sup>5</sup> / <sub>8</sub> " x 1 <sup>1</sup> / <sub>4</sub> "	48 LBS	100
HFSFC1700	1 <sup>7</sup> / <sub>10</sub> " x 2 <sup>1</sup> / <sub>4</sub> "	53 LBS	100
HFSFC2500	2 <sup>1</sup> / <sub>2</sub> " x 3 <sup>1</sup> / <sub>4</sub> "	62 LBS	100
USE CARRIAGE BOLTS (2/Set)			
NB516125	5 <sup>1</sup> / <sub>16</sub> " x 1 <sup>1</sup> / <sub>4</sub> "	46 LBS	1000

Available for Square Post

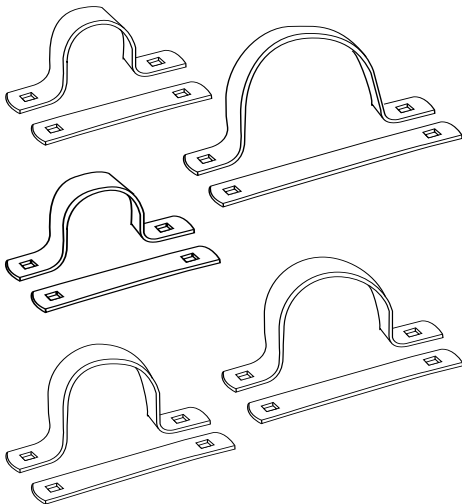

<b>ROUND POST BRACKET</b>			
Part No.	Size	Weight	Quantity
HFSF1660	1 <sup>2</sup> / <sub>3</sub> "	43 LBS	100
HFSF1875	1 <sup>7</sup> / <sub>8</sub> "	47 LBS	100
HFSF2375	2 <sup>3</sup> / <sub>8</sub> "	52 LBS	100
HFSF2875	2 <sup>7</sup> / <sub>8</sub> "	64 LBS	100
HFSF3500	3 <sup>1</sup> / <sub>2</sub> "	72 LBS	100
HFSF4000	4"	72 LBS	100
HFSF4500	4 <sup>1</sup> / <sub>2</sub> "	45 LBS	50
HFSF6625	6 <sup>5</sup> / <sub>8</sub> "	54 LBS	50
USE CARRIAGE BOLTS (2/Set)			
NB516125	5 <sup>1</sup> / <sub>16</sub> " x 1 <sup>1</sup> / <sub>4</sub> "	46 LBS	1000
SpecialOrder:			
HFSF5563	5 <sup>9</sup> / <sub>16</sub> "	48 LBS	50
SUPERCLRC		66 LBS	50

Available Powder Coated Black